

Pohl Metall GmbH
Industriestraße 35
6430 Ötztal Bahnhof
Tirol - Österreich

www.pohlm Metall.at
office@pohlm Metall.at
0043 5266 87520

TÜV
AUSTRIA

ZERTIFIZIERT
EN ISO 9001
ZERTIFIKAT NR. 20100163000469
TÜV AUSTRIA CERT GMBH

Pohl Metall
...Technik mit Know How





SPEZIALISIERT auf PRÄZISE STANZTEILE

Bandabmessungen:

Stärke von 0,2mm bis ca. 4mm

Breite von ca. 25mm bis 280mm

Materialfestigkeit:

von 120 N/mm² bis 1.900 N/mm²,
je nach Geometrie und Werkstoff





INGENIEURBÜRO für MASCHINENBAU und MESSTECHNIK

3 D-Koordinatenmessmaschine,
Härteprüfgerät,
Funken- und
Röntgenspektrometrie,

Rauheitsprüfung,
Glanzgradmessung,
Schichtdickenmessung





INHOUSE 3D-SCANNER
für
GENAUE ANALYSEN
und
3D-DATEN-VERGLEICH

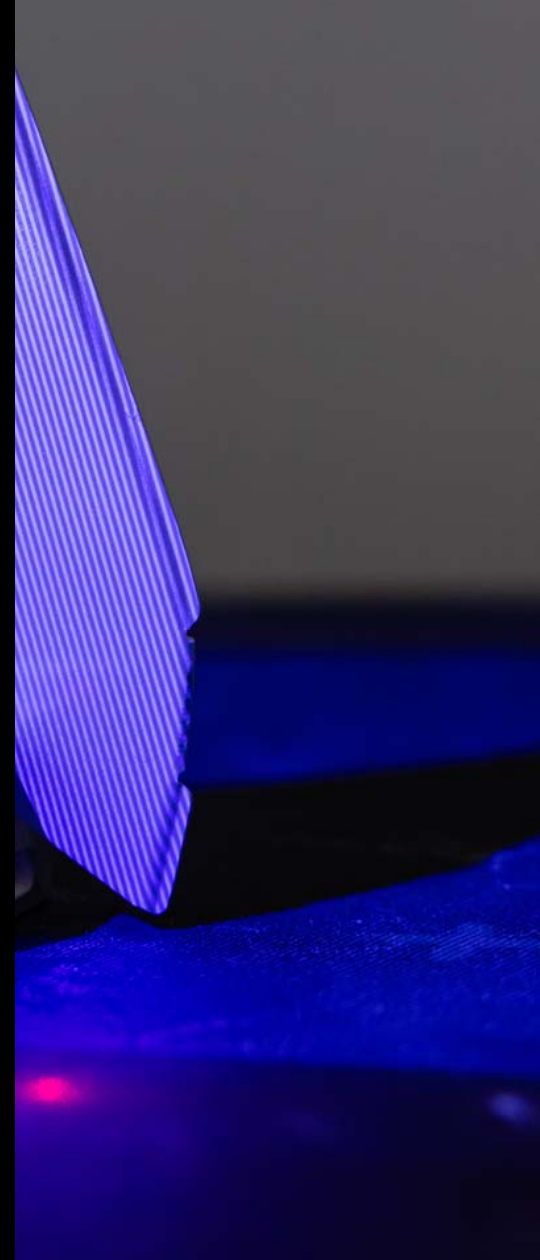



TRIGOS Tirol 2020

URKUNDE

Nominierung in der Kategorie

KLIMASCHUTZ

Pohl Metall GmbH

Msgr. DDr. Michael Landau (Caritas)

Univ.-Prof. DDr. Gerald Schöpfer (Rotes Kreuz)

Mag. Franz Maier (Umweltsachverband)

Ing. Georg Hübner (Industriellenvereinigung)

Dr. Harald Mahrer (WKO)

Ing. Peter Giffinger (respACT)



Trägerorganisationen des
TRIGOS Österreich 2020:



WIR ARBEITEN NACHHALTIG





STANZTEILE

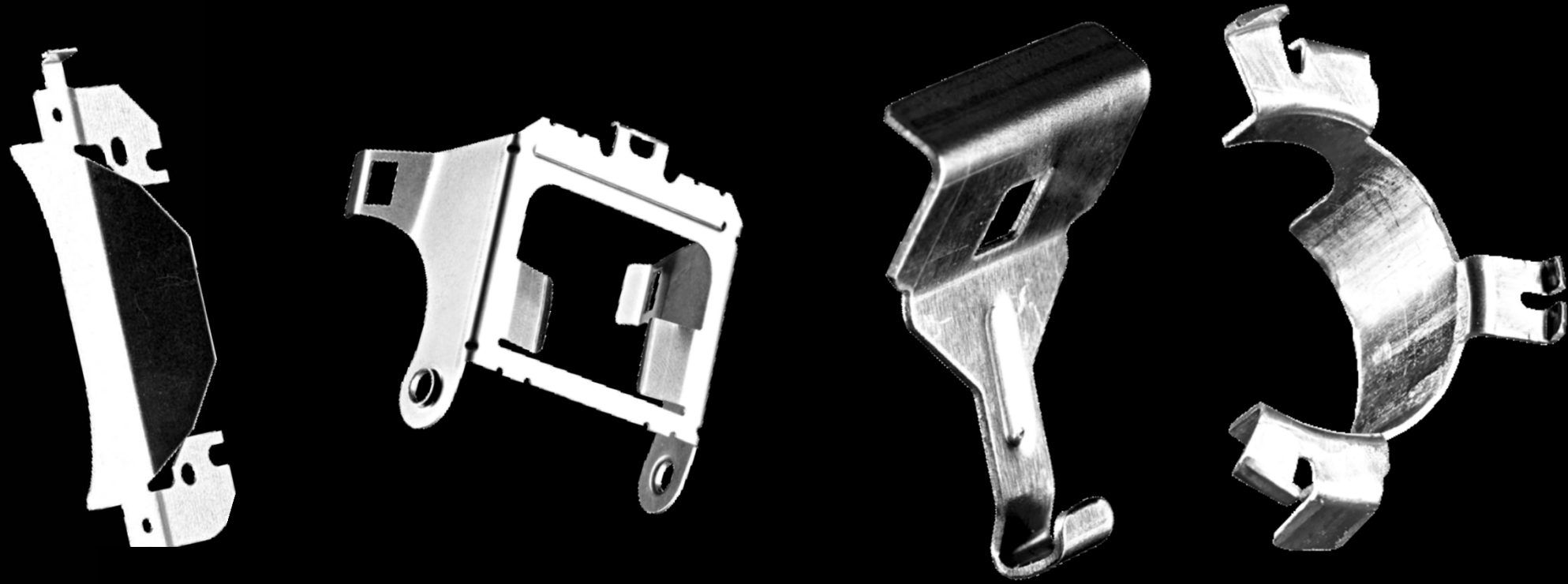

Exakte Stanzteile aus Edelstahl, Aluminium und beschichteten Stahlbändern

KLEINTEILLACKIERUNG

Hitzeschilder, Sonnenschutzbleche
mit besonderen Anforderungen an
die Oberfläche -
Hitze/Korrosionsbeständigkeit

für Anwendungen im
Automobilbereich, Elektrotechnik,
Ofenbau und Kühlanlagen

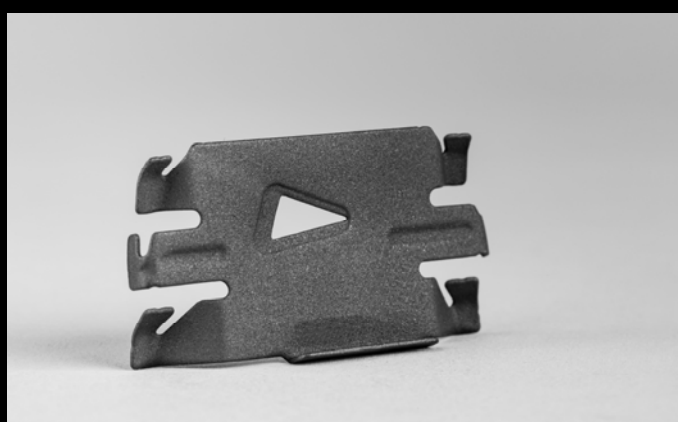
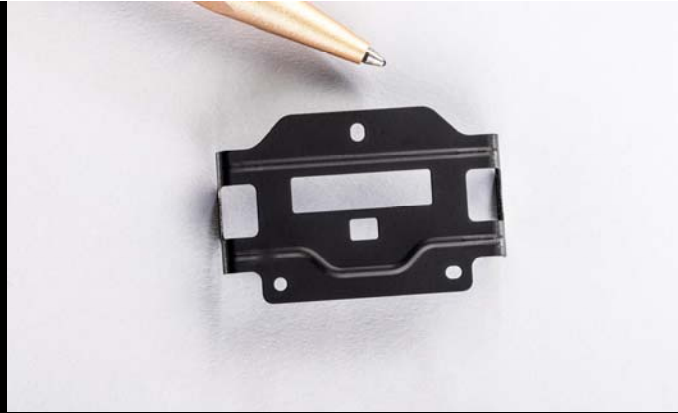

PRÄZISION IN GROSSSERIEN

Hitzeschilder
Strahlenblenden
Kühlkörper
für Autoscheinwerfer

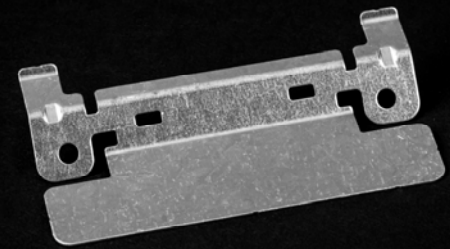

3D-DRAHTBIEGETEILE

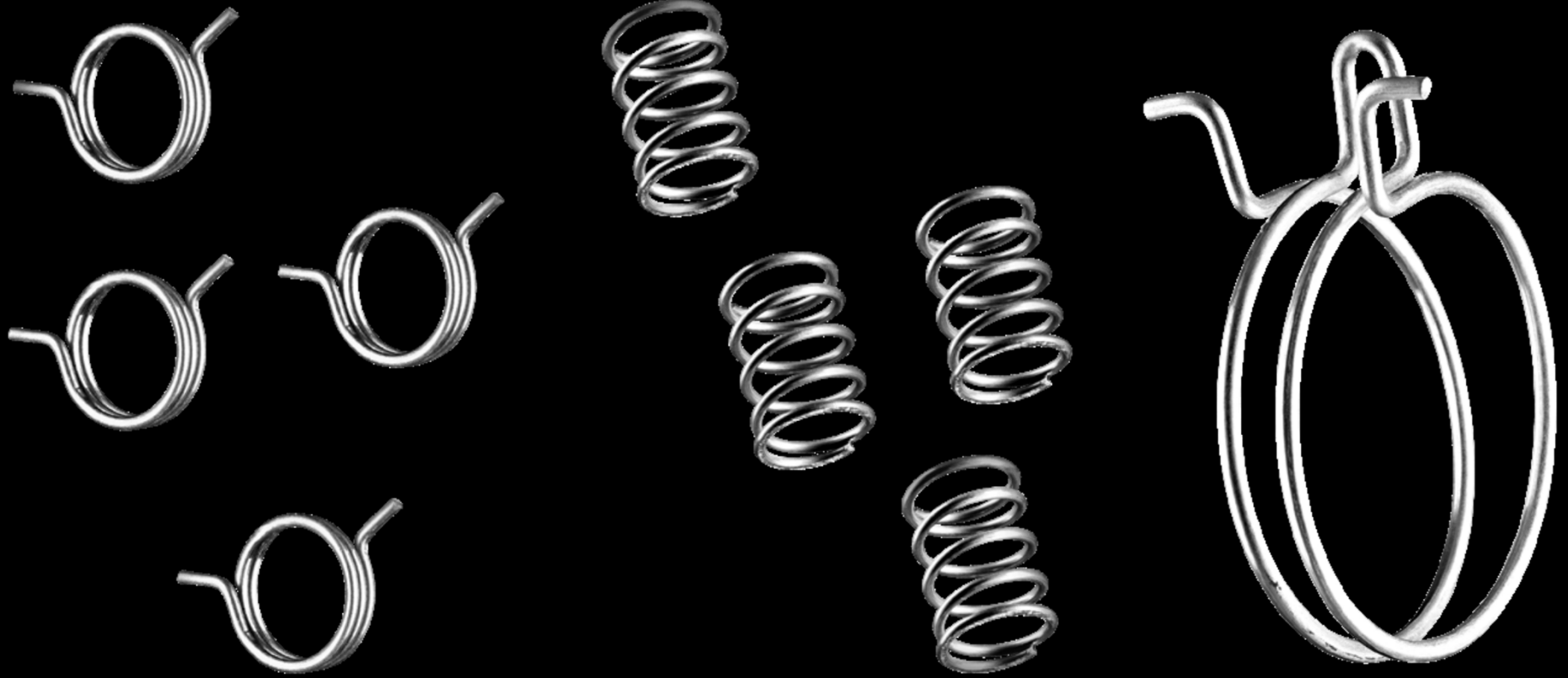

Drehfedern, Halteklammern, Haltebügel

3D-ROHRBIEGETEILE

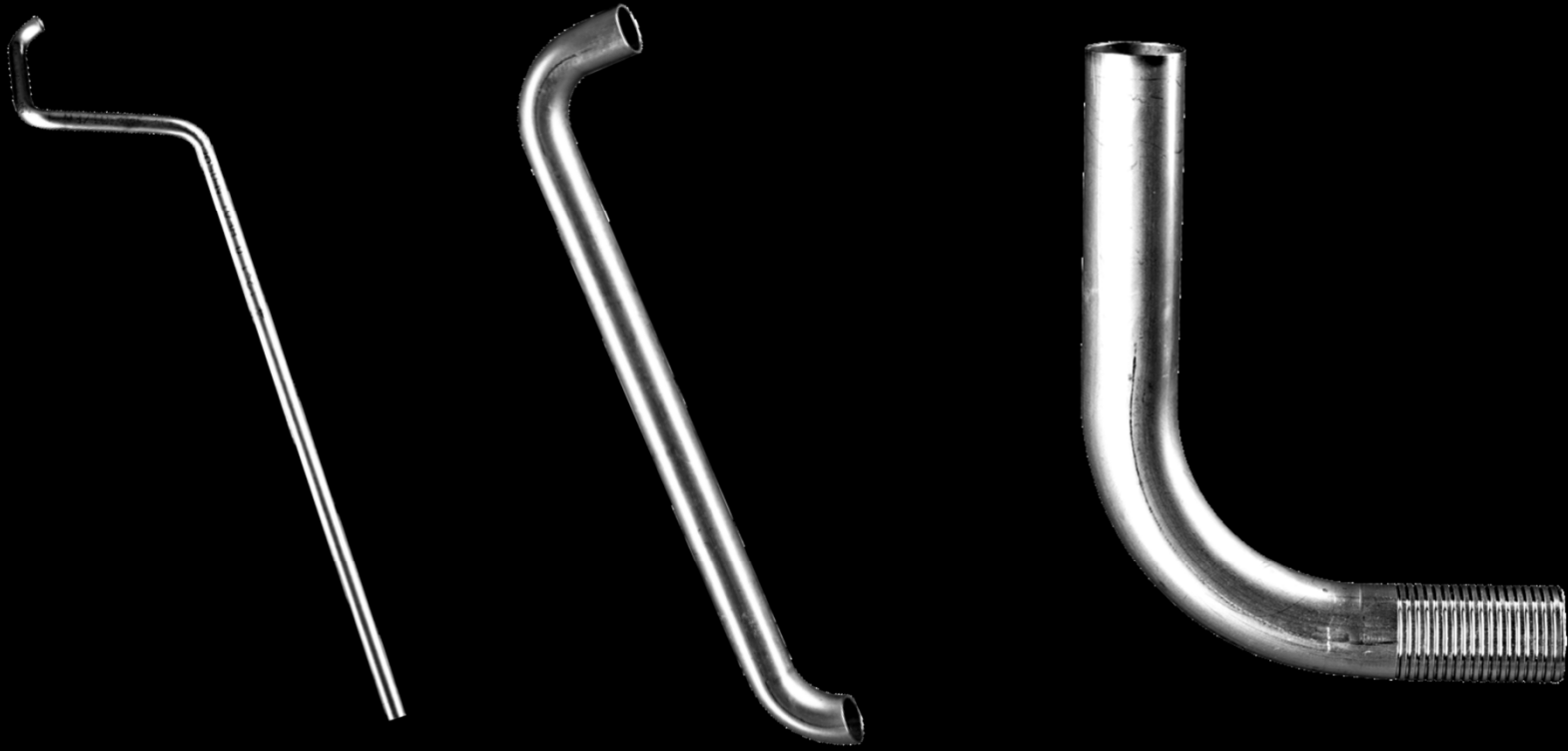

Rohrbiegeteile für Anwendungen im Medizinbereich und Haushaltsgeräten



BAUGRUPPEN

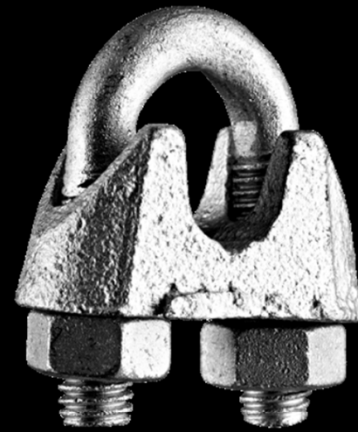

Spann- und Klemmzubehör für den Freileitungsbau, Bahnkomponenten und Bauanwendungen



Ultraschallreinigung

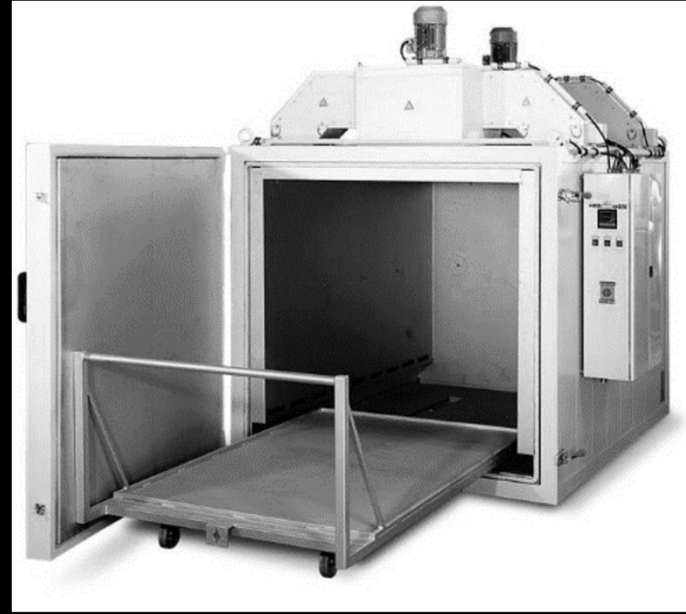

Wärmebehandlung



Sandstrahlen

OBERFLÄCHENBEHANDLUNG



Kleinteillackierung
vollautomatisch oder manuell



AUSZEICHNUNGEN



Staatspreis
KNEWLEDGE 2018
Human Resources Development

des Bundesministeriums
für Digitalisierung
und Wirtschaftsstandort



Das Land Tirol spricht

Pohl Metall GmbH

für die erfolgreiche Teilnahme am Wettbewerb

**FAMILIENFREUNDLICHS-
TER BETRIEB 2019**

Dank & Anerkennung aus:

Patrizia Zoller-Frischauf

Patrizia Zoller-Frischauf
Familien- und Wirtschaftslandesrätin

